

PERICO TIPUS
40 x 40 x 55

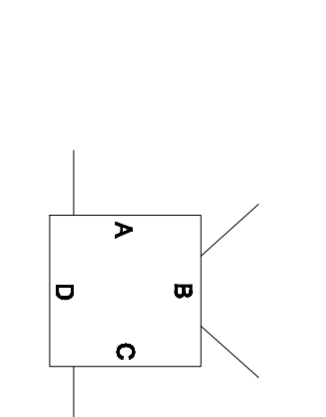

PERICO 40x40

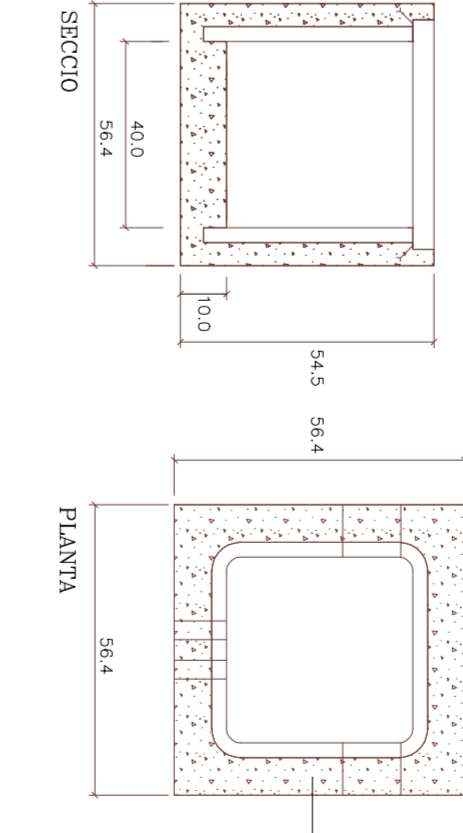

PERICO 40x40

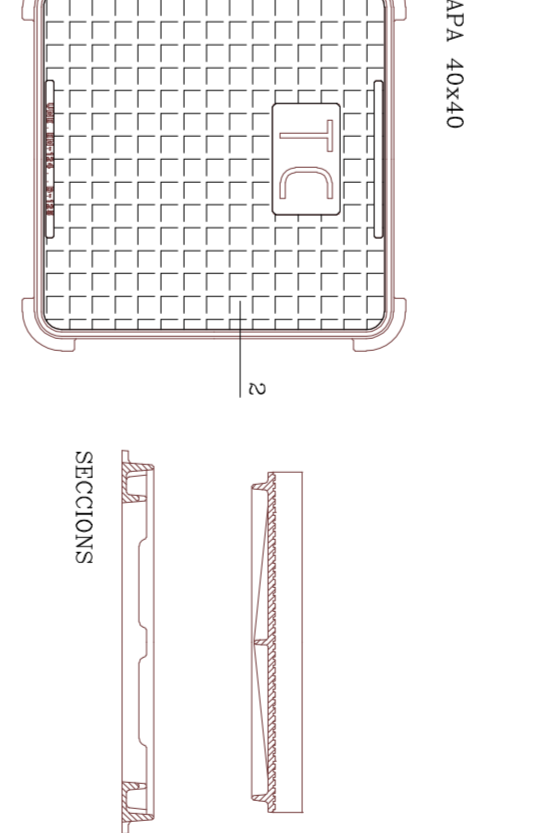

PERICO 40x40

PERICO 40x40

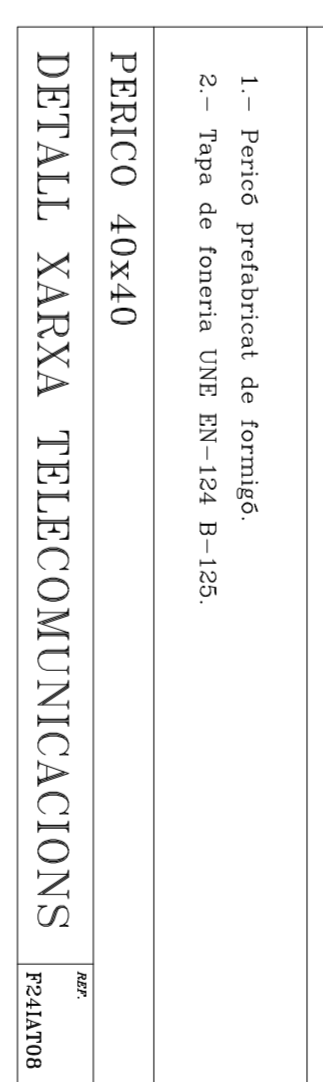

PERICO 40x40

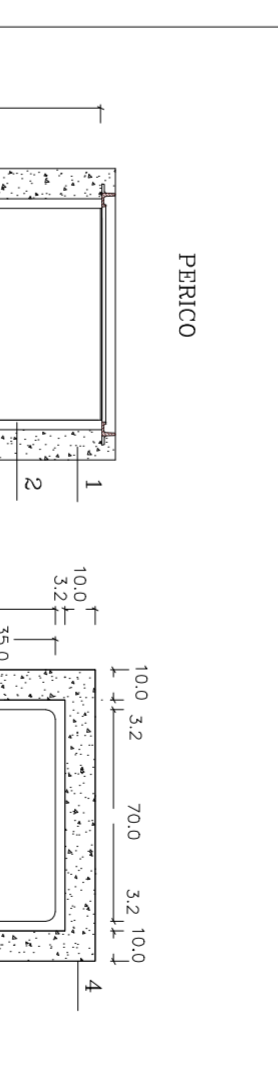

PERICO 40x40

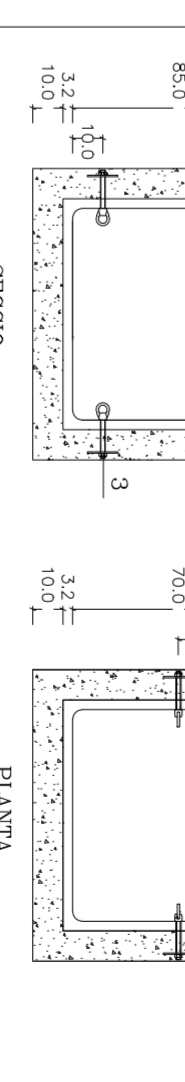

PERICO 40x40

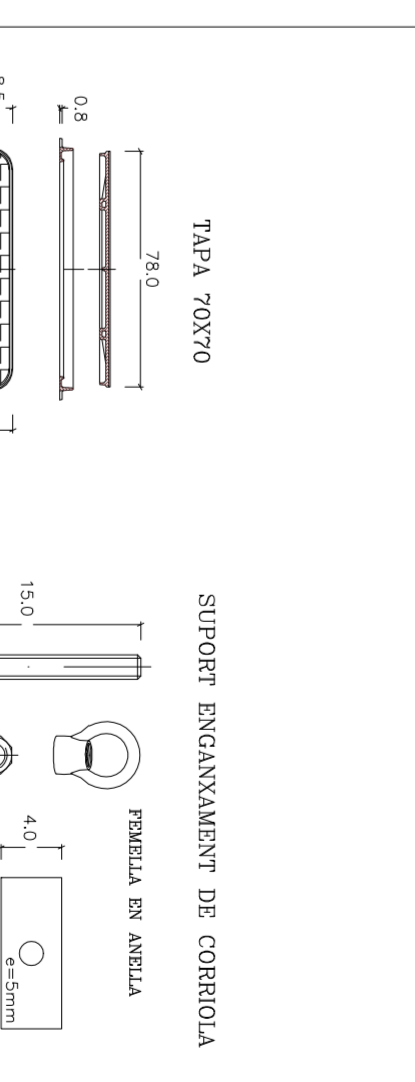

PERICO 40x40

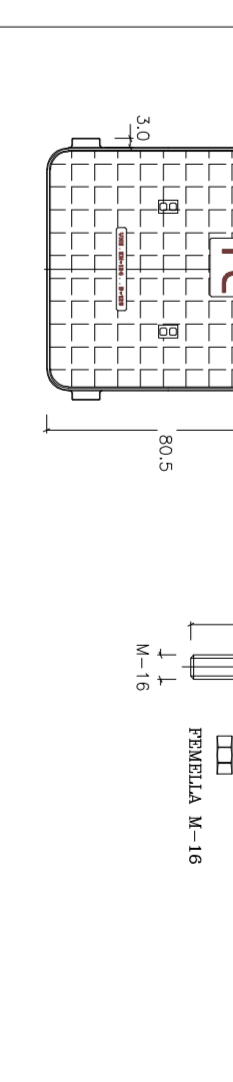

PERICO 40x40

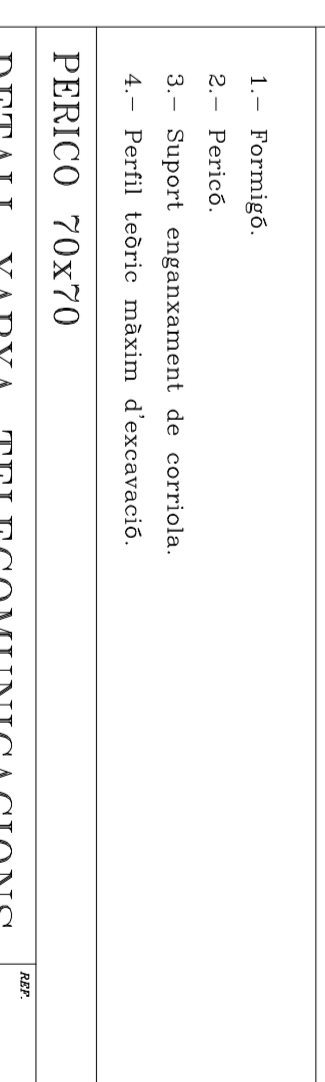

PERICO 40x40

SECCIO VORERA		SECCIO VORERA	
1	34.0	1	60.0
2	24.0	2	54.0
3	14.0	3	48.0
4	4.0	4	42.0
5	0.6	5	36.0
6	0.6	6	30.0
7	0.6	7	24.0
8	0.6	8	18.0
9	0.6	9	12.0
10	0.6	10	6.0
TIBEL A VENTANES EN FINCO DE LA CANALIZACIO			
1	28.0	1	14.0
2	18.0	2	8.0
3	8.0	3	2.0
4	2.0	4	0.6
5	0.6	5	0.6
TIBEL A VENTANES EN FINCO DE LA CANALIZACIO			
1	28.0	1	14.0
2	18.0	2	8.0
3	8.0	3	2.0
4	2.0	4	0.6
5	0.6	5	0.6
TIBEL A VENTANES EN FINCO DE LA CANALIZACIO			
1	28.0	1	14.0
2	18.0	2	8.0
3	8.0	3	2.0
4	2.0	4	0.6
5	0.6	5	0.6

- 1.- Cinta serigrafada.
2.- Separadors 63 mm.
3.- Separadors 125 mm.
4.- Cinta blanca.
5.- Banda imprimitiva.
- SECCIONS BASSES
- DETALL XARXA TELECOMUNICACIONS

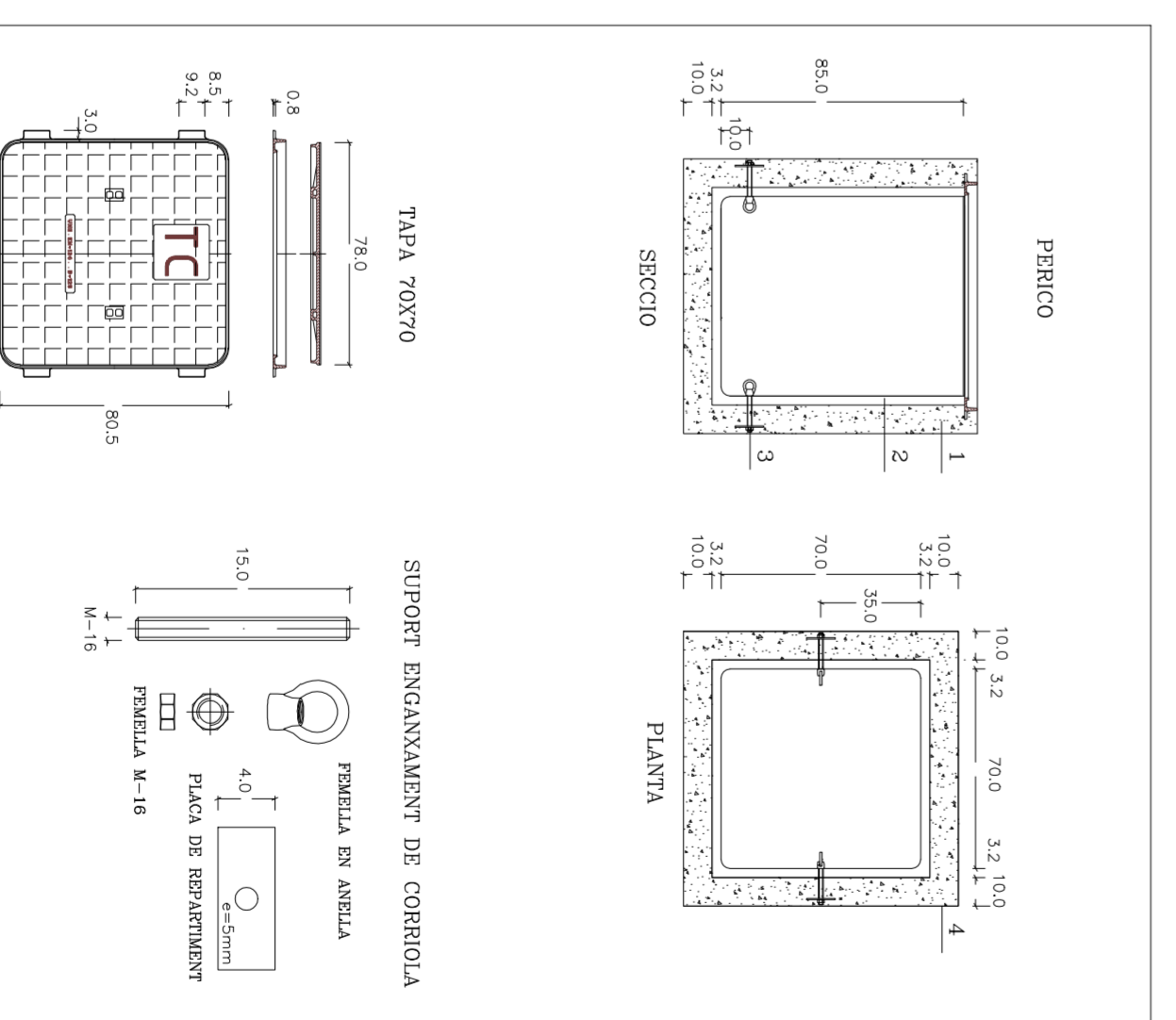

PERICO 40x40

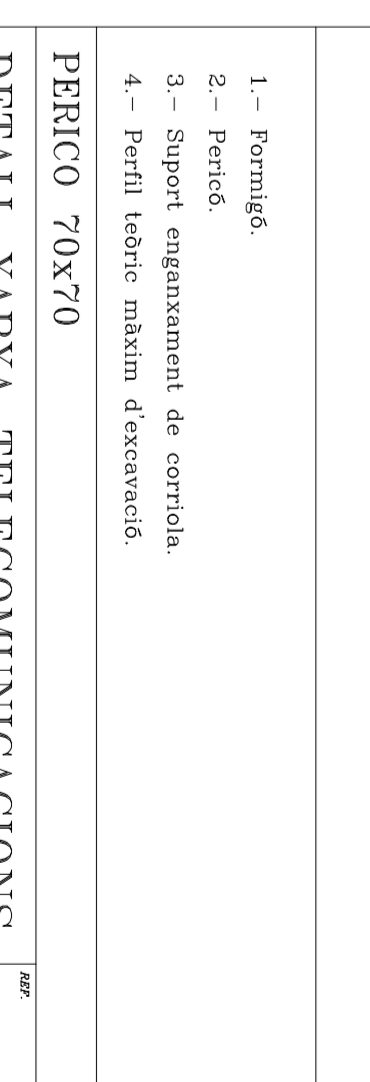

PERICO 40x40

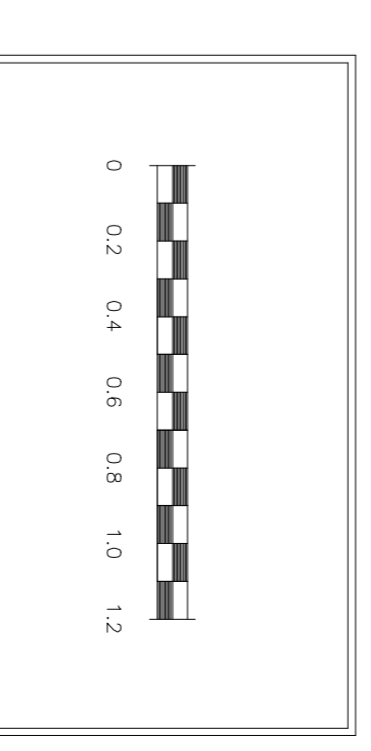
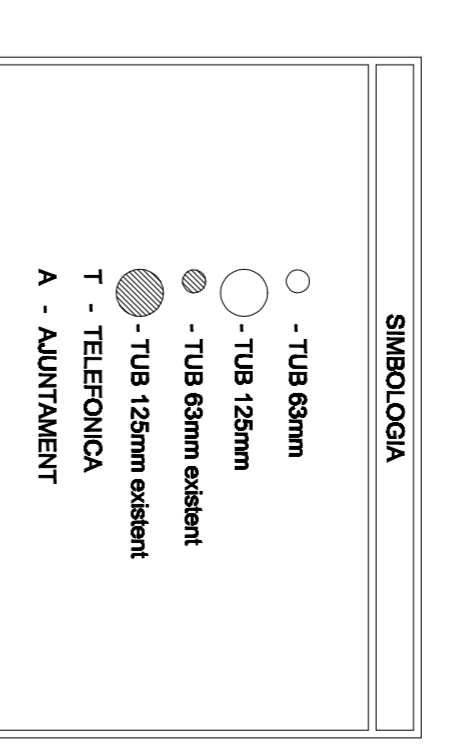

Obra	
PRODUCTE D'UBRANTZACIO	PP7.SUBD-7
SECTOR CANI DE ROQUETES	
TEXT REPOS	
Enginyer	
CARRETERA DE ROQUETES	
4.3500 TORIOSA / TARRAGONA	
Referència	0580P119-1B
Promotor	
JUNTA DE COMPENSACIO	
Referència document n.	19
XARXA DE TELECOMUNICACIONS	
DETALLS PERICONS	
Escala	1/20
Data	JUNY 2010
Tècnic Responsable	